

Varenummer: 20090150

Beskrivelse: E+G Bøjlegreb GN 565.4-20-160-A-EL

Mål

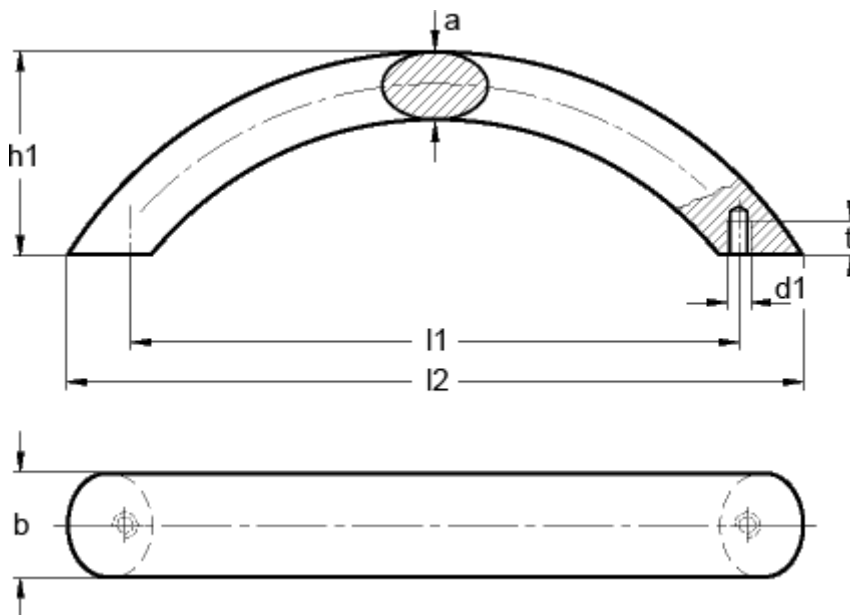

a	= 13
b	= 20
d1	= M6
h1	= 51
l1	= 160
l2	= 185
t min	= 8.5